

HAND-FREE COLOR VIDEO DOORPHONE



Installation and Operation Manual

TABLE OF CONTENTS

1. Brief introduction	1
2. Functions	2
3. Descriptions as illustrated	3
4. Preparations before installation	4
5. Installation	4
6. Wire connection	7
7. Operation	11
8. Note	13
9. Trouble shooting	14
10. Specifications	14

1. Brief introduction

Thanks for using our products, the four wire system video doorphone is a luxury used to unitary flat for safety. It used advanced technology and newest chipset, which improves the stability of the system and far distance. The system has the function such as: hand-free surveillance, visible phone, lock control, infrared vigil, auto turn off, and so on. The system has multi tie-in function such as one camera to one monitor, one to two, two to one, two to two and one to three. Which satisfied by customer's require for different villa.

The products is faddish, goodness, generous, thinner and hanging on the wall, portable, take less place, which as a adornment. The function is dependable and easy to use, it is the perfect family burglarproof facility and widely used in unitary flat, villa, office and public building, which is the best present for your friend.

For the sake of your safety, please use series burglarproof facility! It will make your life safe and easy!

2. Functions

● Powerful function

Hand-free surveillance, auto display while calling, visible phone, lock control, infrared vigil, Auto switching.

● High solution picture

Using the high resolution camera and 4 inch TFT LCD color digital screen. The resolution is $320 \times \text{RGB} \times 240$. The picture is clear, nice, colorful and steady.

● Conveniency in installation

It is very simple to install, easily using and maintain.

● Thinner for hanging on the wall

Faddish, thinner for hanging on the wall, generous, portable, take less place, which as a adornment.

● Multi Connection

The system can be installed in multi tie-in manners as one camera to one monitor, one to two, two to one, two to two and one to three. It can satisfy the kinds of villa.

● Security

Infrared vigil: the system also can watch anything and see the visitor clearly at night. Sure who is there before unlock, which is safer.

3. Descriptions as illustrated

1. Indoor-monitor

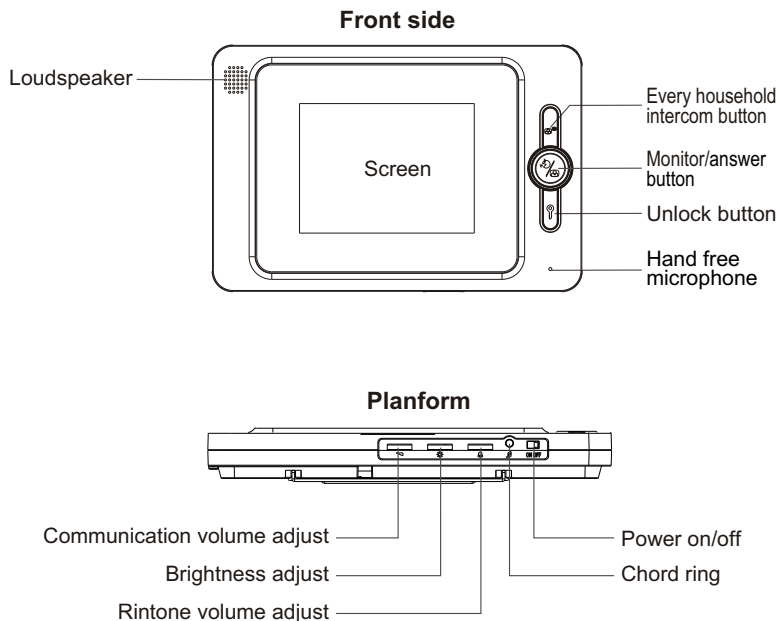

2. Camera

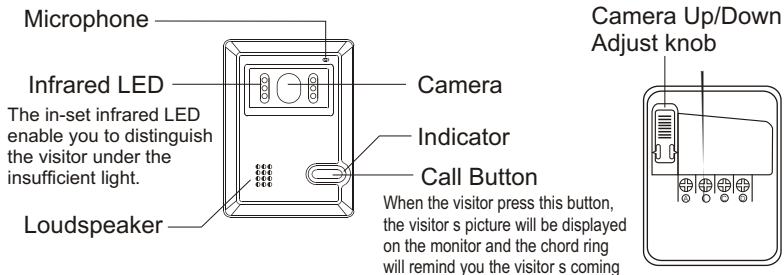

4. Preparations before installation

Check the pack

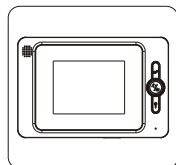

Indoor monitor

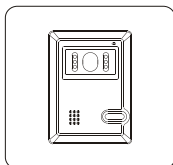

Camera

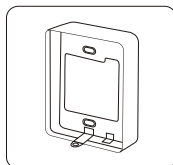

Camera accessory

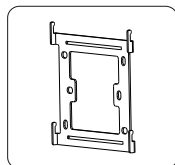

Monitor bracket

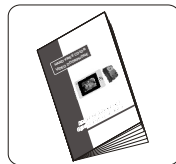

Operation manual

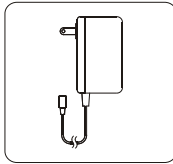

AC adapter



Wire

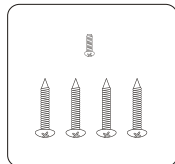

Screw

5. Installation

1. System diagram

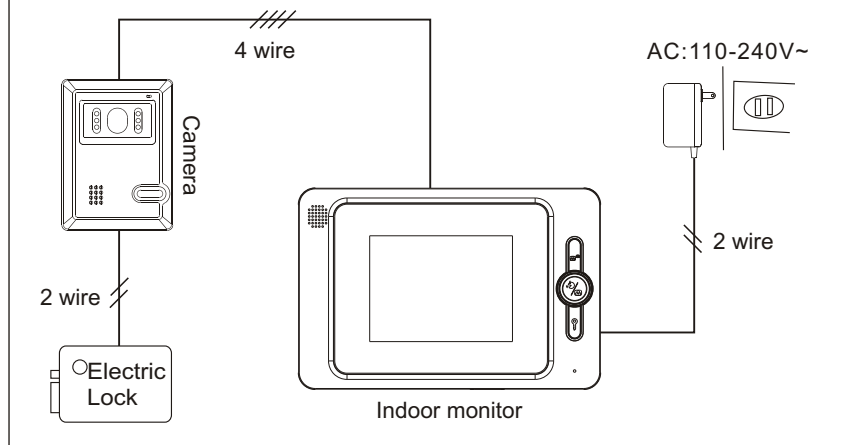

5. Installation

2. Installation of the monitor

The optimum height of the monitor for installation is 145cm~160cm from the centre of the screen of the monitor to the ground. (This data provides to consult only)

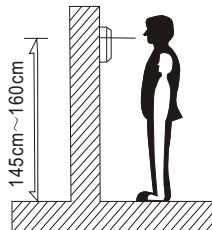

※ Please follow the below steps before installation:

1. Take two bolts fix the bottom piece on the wall and then install the monitor

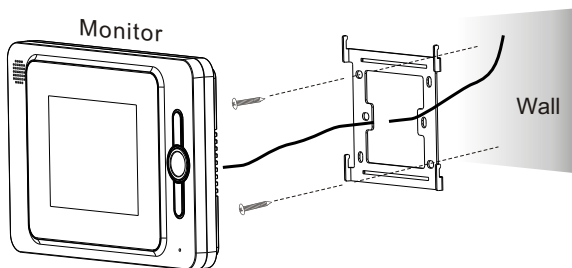

2. Push indoor unit to mount bracket from the top down.

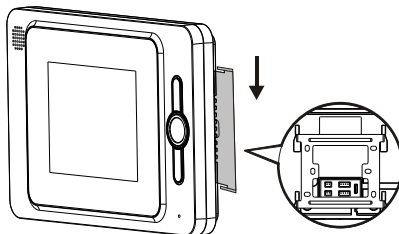

※ In case to pull out the indoor unit, please follow the step 1 and 2.

5. Installation

3. Installation of the camera

Positioning

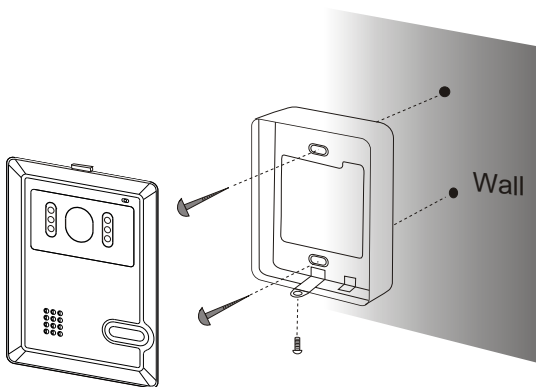
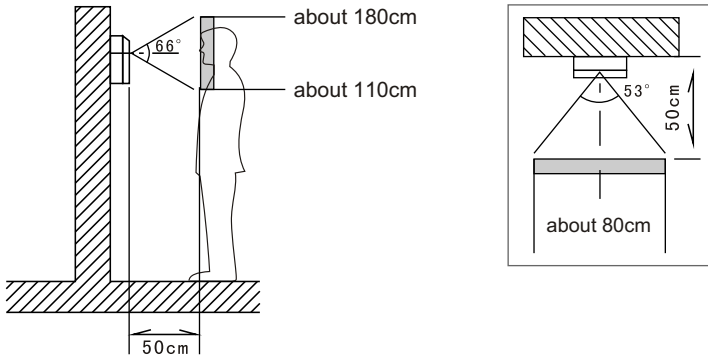

※ **Notice:**

Do not install the camera on the places under the sunshine. If the street light or other light reflect at the back of the visitor, you need to install lamps to make the picture more clearer.

6. Wire connection

1. Diagram of one to one

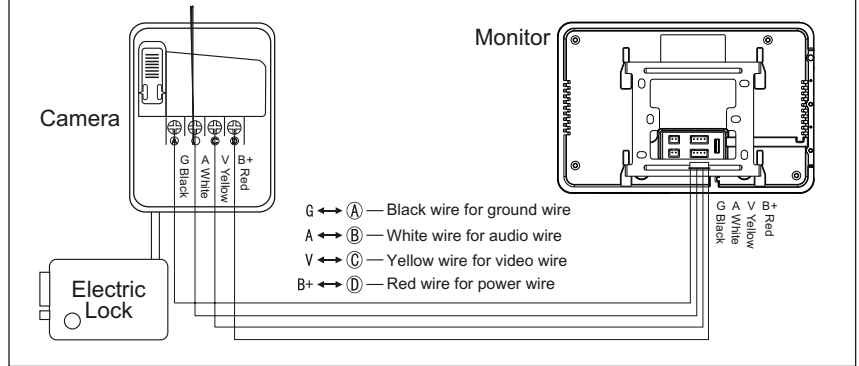

2. Diagram of one to two

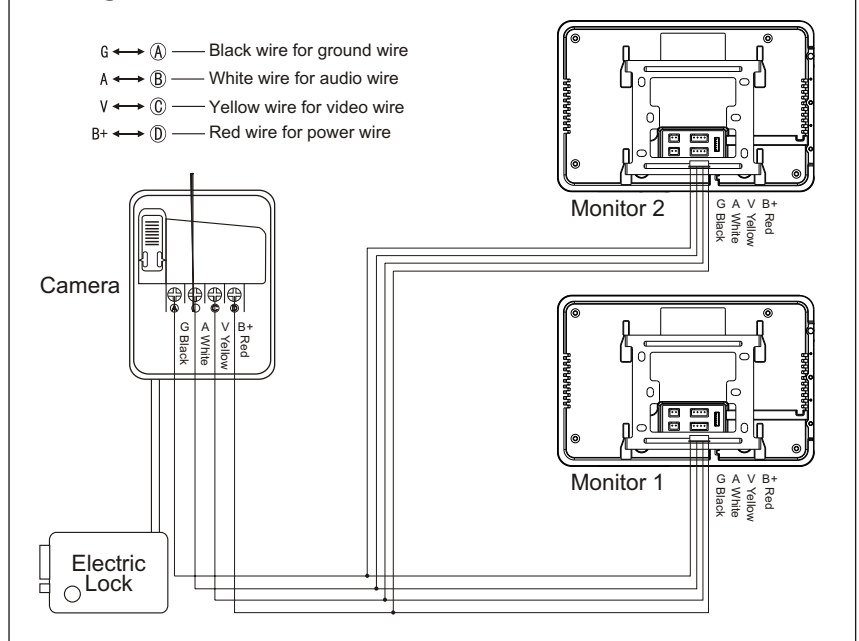

6. Wire connection

3. Diagram of one to three

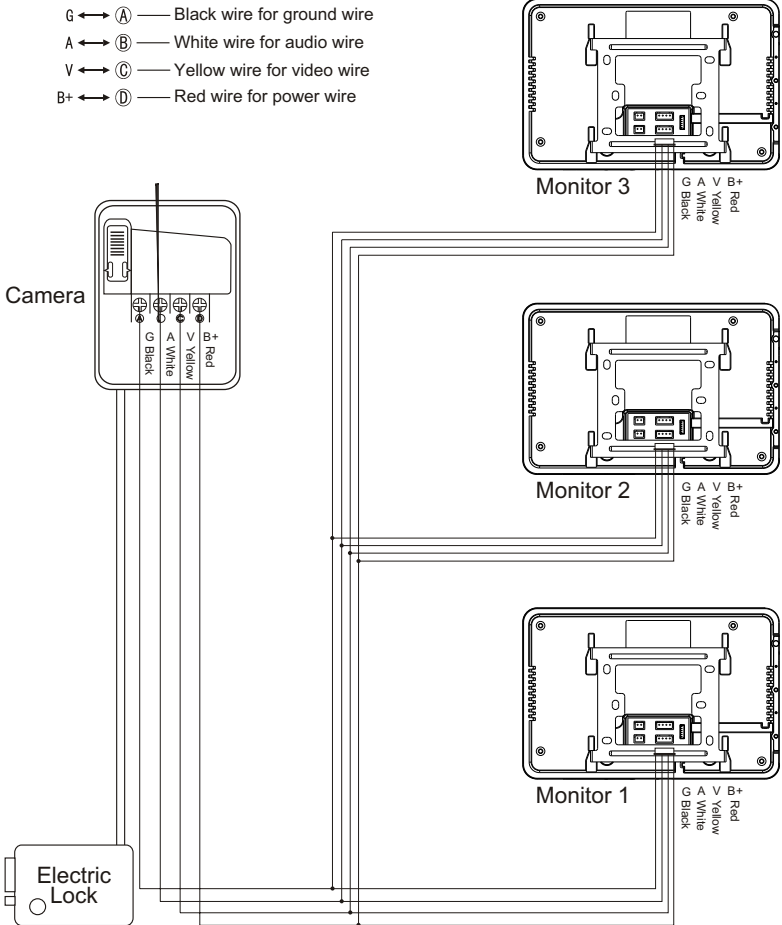

6. Wire connection

4. Diagram of two to one

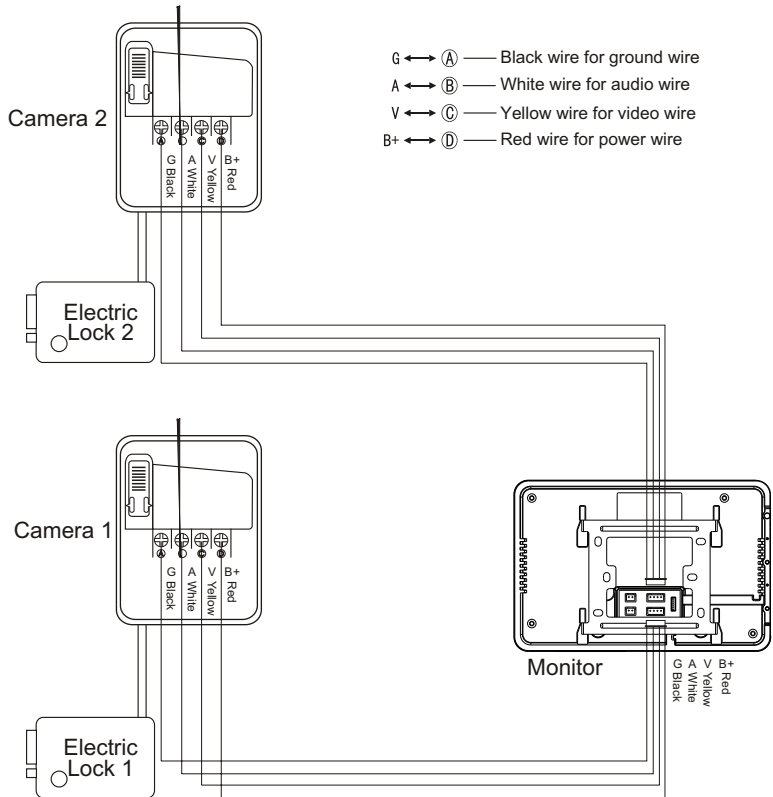

Notice

1. Before install, please plug off the power supply cord. And plug the power supply cord after installation.
2. The length connecting wire between the camera and the monitor must be less than 100 metres.
3. For the clear picture, it is recommended to use the copper wire of $4 \times 0.75\text{mm}^2$.

7. Operation

◆ Calling by the visitor

While the visitor press the Call button, the Ding Dong sound will be heard from the indoor monitor, and the picture of the visitor is displayed on the monitor screen. If no people at home or fail to press Monitor/answer button in time, the screen will be closed automatically at 60 seconds.

When seeing the picture of the visitor, press the Monitor/answer button to communicate with the visitor, and press the button again to turn off the monitor. If the communicate continue over 60 seconds, the screen will be closed automatically.

You can press the Unlock button to open the door and let the visitor in.

◆ In house intercom:

While standby mode, click "intercom" button, thereafter, the other indoor monitors will Ring, and they can pick up the handset or click answer button to communicate.

(PS.: there must be more than one indoor monitor to be connected in the system to achieve this function)

◆ Stakeout

While standby state, press the Monitor button to display the outdoor picture.

◆ Other operation

If you think the monitor volume is not applicable or the picture shown on the screen is too light or too dark, you can adjust the Communication volume, Brightness and Rintone volume knob to reach pleased effect of volume and picture.

7. Operation



①

Press the Call button by the visitor.



②

The picture of the visitor is displayed on the monitor screen.



③

Press the Monitor/answer button to communicate with the visitor.



④

Press the Unlock button to open the door.



⑤

On standby, press the Monitor/answer button then the outside picture is in stakeout.

8. Note

As illustrated

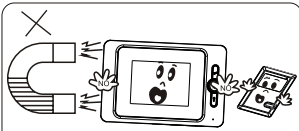

Do not put the doorphone near the strong magnetic places.

1

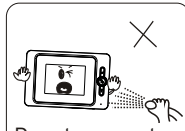

Do not spray water or liquid to the video doorphone directly.

2

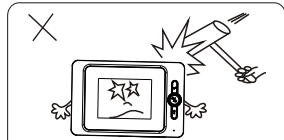

Do not shock the video doorphone

3



Do not expose video phone to the sunshine or strong reflection ray.

4

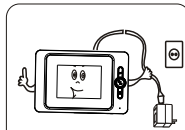

Plug off the power cord while not use for a long time.

5

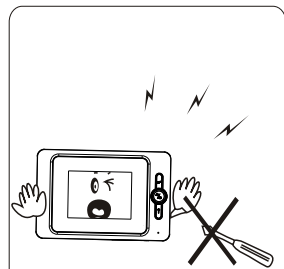

Do not try to dismantle the doorphone, as the high voltage is inside it.

8

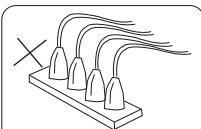

Do not insert plugs into a socket to be filled. (This will be caused a fire or short circuit)

6

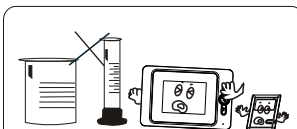

Do not installed the doorphone near any ammonia or poisonous gas.

7

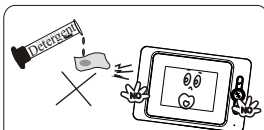

Do not wipe the machine with detergent or other chemic impregnant.

9



Do not try to dismantle the machine while failure to function. Please contact with the local service.

10

9. Trouble shooting

1. No sound while calling
 - a. The connection cable between monitor and camera is loose.
 - b. The volume has be turned to the end.
2. Unclear image

Please check if the brightness is turned to too down, please adjust the brightness knob.
3. Can not unlock

The wire of unlock is unconnected or short circuit.

10. Specifications

Indoor-monitor

Power Supply	DC13.5V
Power Consumption	Standby: < 1W; Working: ≤8W
Screen	4" TFT color digital screen
Resolution	320 × RGB × 240
Brightness	250cd/m ²
Video Input	1Vp_p
Cutoff-Time	Stakeout: 1 minute; Conversation: 1 minute
Mike Sensitivity	-36dB
Operation Temperature	-10°C ~ +55°C
Call Tone	chord ring
External Dimension	180(L) × 122(W) × 23(H)mm

Outdoor-camera

Power Supply	DC 12V(supplied by the monitor)
Power Consumption	Working: < 2W
Imagery Angle	Diagonal: about 53°
Lamp-house at Night	Infrared LED
Operation Temperature	-15°C ~ +50°C
External Dimension	127(L) × 95(W) × 35(H) mm

Warning:

- ※ To prevent injury, this apparatus must be securely attached to the floor/wall in accordance with the installation instructions.
- ※ The mains plug is used as the disconnect device, the disconnect device shall remain readily operable, and it shall be disconnected from the mains completely.
- ※ The plug is used as disconnect device from the mains supply, the plug shall remain readily operable.
- ※ The apparatus should not be exposed to dripping or splashing and that no objects filled with liquids, such as vases, shall be placed on the apparatus.
- ※ No naked flame sources, such as lighted candles, should be placed on the apparatus.

Notice:

- ※ Due to continuing improvements, the features and design are subject to change without notice.
- ※ This manual is only intended for reference. No further notice is available to any modification of all information contained therein.
- ※ For the imprecision, mistake or misprint in the manual, will be explained by the producer only.

We are connected by true feeling !



Door Guard

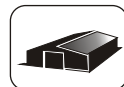

Warehouse



Baby Room

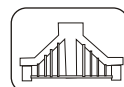

Gate Switch

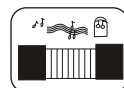

Visitor Door

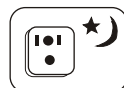

Night Vision



Inter-com

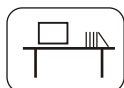

Office